

# MULTI-MONTI<sup>®</sup>-plus

## European Technical Assessment ETA-15/0785

Fasteners for use in concrete  
for redundant non-structural systems





Approval body for construction products  
and types of construction

Bautechnisches Prüfamt

An institution established by the Federal and  
Laender Governments



## European Technical Assessment

ETA-15/0785  
of 20 June 2019

English translation prepared by DIBt - Original version in German language

### General Part

Technical Assessment Body issuing the  
European Technical Assessment:

Deutsches Institut für Bautechnik

Trade name of the construction product

MULTI-MONTI-plus

Product family  
to which the construction product belongs

Fasteners for use in concrete for redundant non-structural  
systems

Manufacturer

HECO-Schrauben GmbH & Co. KG  
Dr.-Kurt-Steim-Straße 28  
78713 Schramberg  
DEUTSCHLAND

Manufacturing plant

HECO-Schrauben GmbH & Co. KG

This European Technical Assessment  
contains

15 pages including 3 annexes which form an integral part  
of this assessment

This European Technical Assessment is  
issued in accordance with Regulation (EU)  
No 305/2011, on the basis of

EAD 330747-00-0601

The European Technical Assessment is issued by the Technical Assessment Body in its official language. Translations of this European Technical Assessment in other languages shall fully correspond to the original issued document and shall be identified as such.

Communication of this European Technical Assessment, including transmission by electronic means, shall be in full. However, partial reproduction may only be made with the written consent of the issuing Technical Assessment Body. Any partial reproduction shall be identified as such.

This European Technical Assessment may be withdrawn by the issuing Technical Assessment Body, in particular pursuant to information by the Commission in accordance with Article 25(3) of Regulation (EU) No 305/2011.

## Specific Part

### 1 Technical description of the product

The HECO screw anchor MULTI-MONTI-plus is an anchor of sizes 6, 7.5 and 10 mm made of galvanised steel. The anchor is screwed into a predrilled cylindrical drill hole. The special thread of the anchor cuts an internal thread into the member while setting. The anchorage is characterised by mechanical interlock in the special thread.

The product description is given in Annex A.

### 2 Specification of the intended use in accordance with the applicable EAD

The performances given in Section 3 are only valid if the anchor is used in compliance with the specifications and conditions given in Annex B.

The verifications and assessment methods on which this European Technical Assessment is based lead to the assumption of a working life of the anchor of at least 50 years. The indications given on the working life cannot be interpreted as a guarantee given by the producer, but are to be regarded only as a means for choosing the right products in relation to the expected economically reasonable working life of the works.

### 3 Performance of the product and references to the methods used for its assessment

#### 3.1 Safety in case of fire (BWR 2)

Essential characteristic	Performance
Reaction to fire	Class A1
Resistance to fire	See Annex C 2

#### 3.2 Safety in use (BWR 4)

Essential characteristic	Performance
Characteristic resistance to tension load (static and quasi-static loading)	See Annex C 1 and C 2
Characteristic resistance to shear load (static and quasi-static loading)	See Annex C 1 and C 2

### 4 Assessment and verification of constancy of performance (AVCP) system applied, with reference to its legal base

In accordance with European Assessment Document EAD No. 330747-00-0601, the applicable European legal act is: [97/161/EC].

The system to be applied is: 2+

**5 Technical details necessary for the implementation of the AVCP system, as provided for in the applicable European Assessment Document**

Technical details necessary for the implementation of the AVCP system are laid down in the control plan deposited at Deutsches Institut für Bautechnik.

Issued in Berlin on 20 June 2019 by Deutsches Institut für Bautechnik

BD Dipl.-Ing. Andreas Kummerow  
Head of Department

*beglaubigt:*  
Tempel

### Installed condition

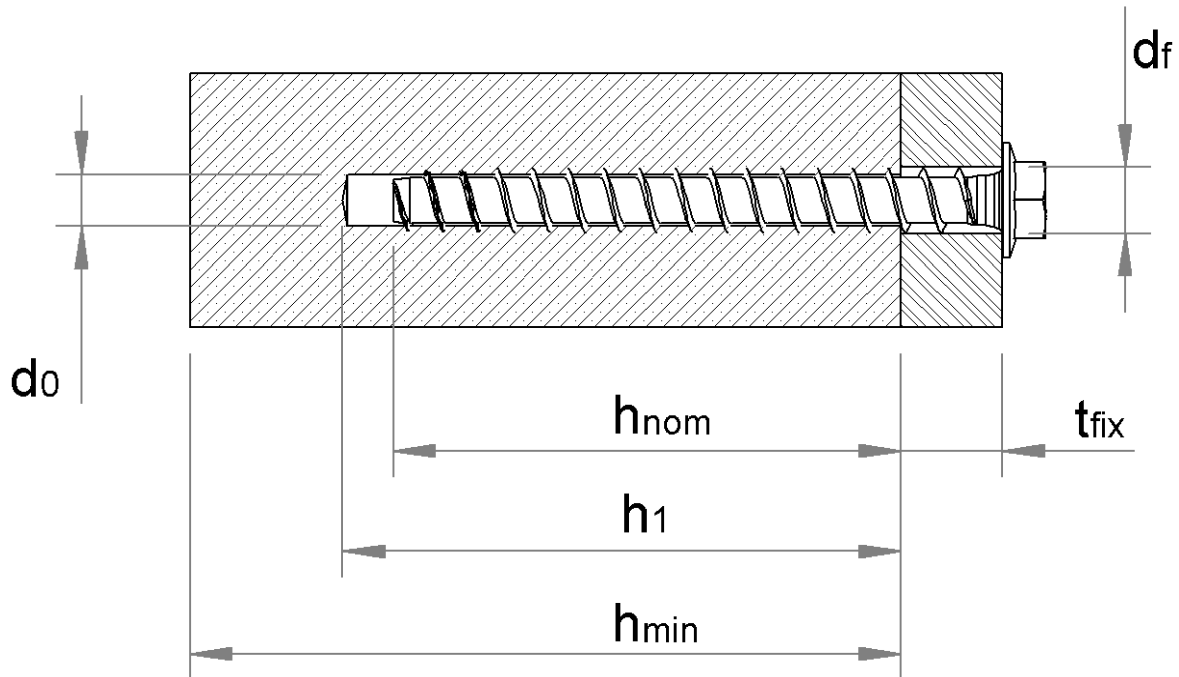

E.g.: MMS-plus SS (hexagon head with combined washer)

- $d_0$  = nominal borehole diameter
- $h_{nom}$  = nominal anchorage depth
- $h_1$  = borehole depth
- $h_{min}$  = minimum thickness of concrete member
- $t_{fix}$  = thickness of fixture
- $d_f$  = diameter of clearance hole in the fixture

### MULTI-MONTI-plus

Product description  
Product in the installed state

Annex A 1

## Installed condition in prestressed hollow core slabs

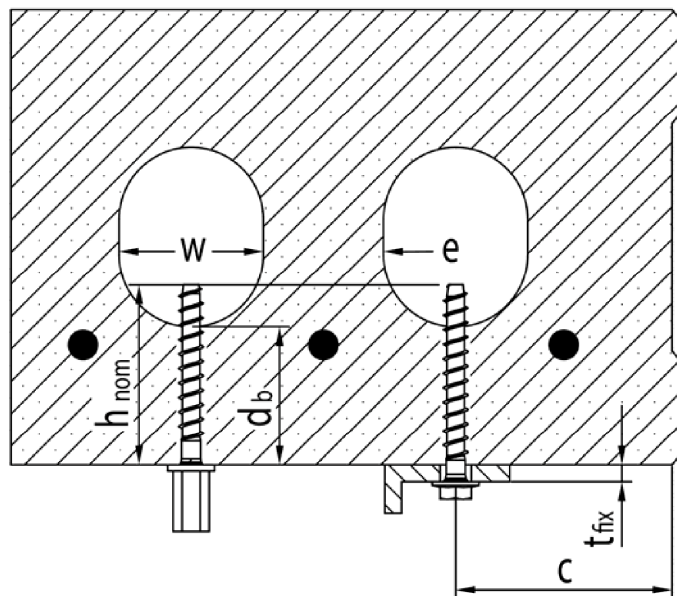

E.g.: MMS-plus I (head version with metric stud and coupling sleeve, hexagon head version with combined washer)

$d_b$	=	bottom flange thickness
$h_{nom}$	=	nominal anchorage deep
$w$	=	core width
$e$	=	web width between two core's
$t_{fix}$	=	thickness of fixture
$c$	=	edge distance











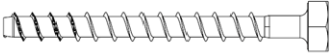

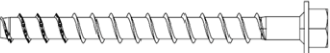





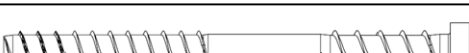

**MULTI-MONTI-plus**

Product description  
Product in the installed state

**Annex A 2**



**Table A1: Material and screw types**

Type	Marking / Material					
1, 2, 3, 4, 5, 6, 7, 8, 9, 10	screw anchor / steel <sup>1)</sup>					
	<b>Size MMS-plus</b>			<b>6</b>	<b>7,5</b>	<b>10</b>
	nominal value of the characteristic yield strength	$f_{yk}$	[N/mm <sup>2</sup> ]	640	640	640
	nominal value of the characteristic tensile strength	$f_{uk}$	[N/mm <sup>2</sup> ]	800	800	800
	elongation at rupture	A <sub>5</sub>	[%]	≤ 8		
1) galvanized steel according to EN 10263-4:2001 (multi-layered coating systems are possible)						
			1) MULTI-MONTI-plus S, with and without washer (alternative design with cone under the head)			
			2) MULTI-MONTI-plus SS, with hexagon head and washer (alternative design with cone under the head)			
			3) MULTI-MONTI-plus P, PanHead, with small pan head			
			4) MULTI-MONTI-plus MS, mounting bar-anchor, with large pan head			
			5) MULTI-MONTI-plus F, with countersunk head			
			6) MULTI-MONTI-plus FT, with countersunk head, thread underneath the head and single- or multi-start thread			
			7) MULTI-MONTI-plus ZT, with cylinder head, thread underneath the head and single- or multi-start thread (alternative forms ST, SST & PT possible)			
			8) MULTI-MONTI-plus ST, anchor with metric stud			
			9) MULTI-MONTI-plus I, anchor with metric stud for mounting of nuts (pre-assembled with sleeve)			
			10) MULTI-MONTI-plus V, anchor with metric stud			

**MULTI-MONTI-plus**

Product description  
Dimensions and screw types

**Annex A 3**

**Table A2: Dimensions and head markings**

Size MMS-plus			6			7,5			10
Embedment depth in concrete [mm]			$h_{nom}$			$h_{nom}$			$h_{nom}$
			25	35	45	25	35	55	50
Thread diameter	$d_s$	[mm]	6,65			7,75			10,5
Bolt diameter	$d_k$	[mm]	4,3			5,45			7,3
Length	$L \geq$	[mm]	25			25			50
	$L \leq$	[mm]	500			500			500

**Head marking**

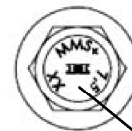
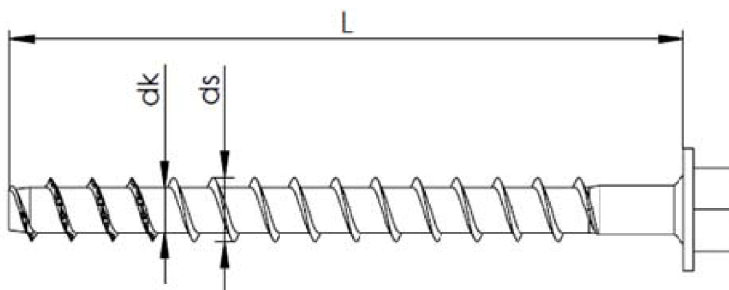

**Head marking**

Factory signs: H  
Anchor type: MMS+  
Anchor size: z.B. 7,5  
Anchor length: z.B. 80

**Bolt marking**

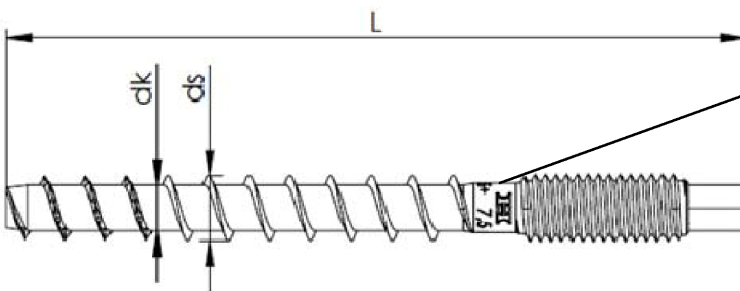

**Marking**

Factory signs: H  
Anchor type: MMS+  
Anchor size: z.B. 7,5  
Anchor length: z.B. 80



**MULTI-MONTI-plus**

**Product description**  
Dimensions and head marking

**Annex A 4**

## Specifications of intended use

### Anchorage subject to:

- Static and quasi static loads: All sizes.
- Used in concrete for redundant non-structural systems only.
- Fire exposure: All sizes (not in prestressed hollow core slabs).

### Base materials:

- Compacted reinforced or unreinforced normal weight concrete without fibres according to EN 206:2013.
- Strength classes C20/25 to C50/60 according to EN 206:2013.
- Cracked and uncracked concrete.
- Prestressed hollow core slabs made of C30/37 to C50/60.

### Conditions of use (Environmental conditions):

- Structures subject to dry internal conditions.

### Design:

- Anchorages are designed under the responsibility of an engineer experienced in anchorages and concrete work.
- Verifiable calculation notes and drawings are prepared taking the loads to be anchored into account. The position of the anchor is indicated on the design drawings (e. g. position of the anchor relative to reinforcement or to supports, etc.).
- Anchorages are designed in accordance with EN 1992-4:2018 and EOTA Technical Report TR 055
- The design under shear load according to EN 1992-4:2018, section 6.2.2 applies to all anchors in Annex B 2, Table B1 specified diameter  $d_f$  of clearance hole in the fixture.

### Installation:

- Hole drilling by hammer-drilling only.
- Anchor installation carried out by appropriately qualified personnel and under the supervision of the person responsible for technical matters of the site.
- After installation further turning of the anchor must not be possible.
- The head of the anchor is attached to the fixture and is not damaged, respectively the required embedment depth is reached.
- In prestressed hollow core slabs the screw anchor may be installed from both sides of slabs (top and bottom side), but only in uncracked concrete. The thickness of slab webs and installation parameters according to Table B2 have to be observed (also in the area of solid material).

**MULTI-MONTI-plus**

Intended Use  
Specification

**Annex B 1**

**Table B1: Installation parameters MMS-plus**

Size MMS-plus			6			7,5			10
Embedment depth in concrete [mm]			$h_{nom}$			$h_{nom}$			$h_{nom}$
			25	35	45	25	35	55	50
Nominal drill diameter	$d_0$	[mm]	5			6			8
Cutting edge-Ø	$d_{cut} \leq$	[mm]	5,40			6,40			8,45
Borehole depth	$h_1 \geq$	[mm]	30	40	50	30	40	60	60
Diameter of clearance hole in the fixture	$d_f \leq$	[mm]	7			9			12,5
Diameter of countersunk head	$d_h$	[mm]	11,5			15,5			19,5
Min. thickness of the concrete member	$h_{min}$	[mm]	80						
cracked and uncracked concrete	min. spacing	$s_{min}$	[mm]	30		30	35		35
	min. edge distance	$c_{min}$	[mm]	30		30	30		35
Recommended installation tool		[Nm]	Impact screw driver, max. power output $T_{max}$ according to manufacturer information						
			60	75	100	60	120		250
Torque moment for threaded version (MMS-plus V)	$T_{inst}$	[Nm]	-			15			20

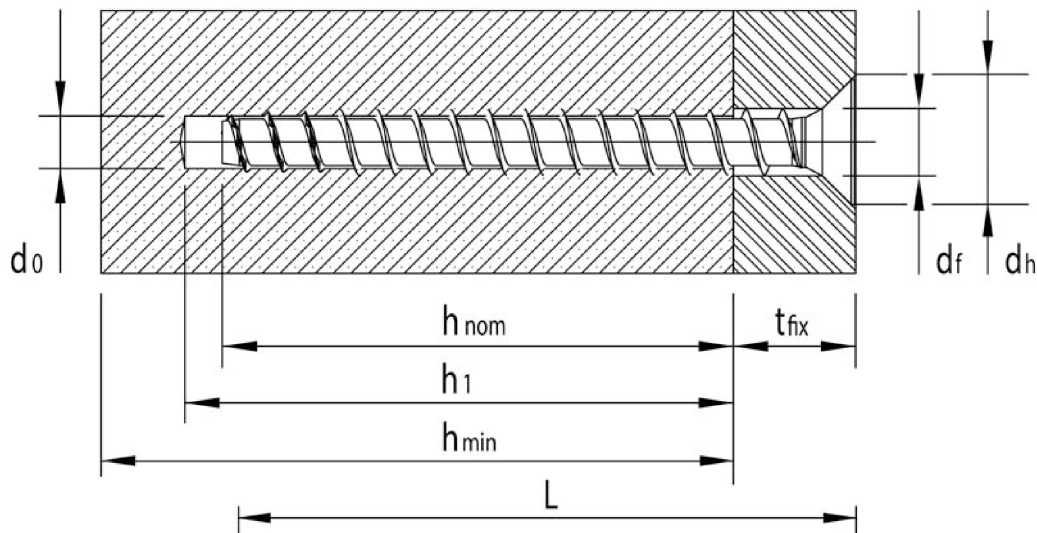

**MULTI-MONTI-plus**

Intended Use  
Installation parameters

**Annex B 2**

**Table B2: Installation parameters MMS-plus in prestressed hollow core slabs**

	<p>core distance <math>l_c \geq 100 \text{ mm}</math></p> <p>spacing of prestressing strands <math>l_p \geq 100 \text{ mm}</math></p> <p>spacing between anchor position and prestressing strands <math>a_p \geq 50 \text{ mm}</math></p>
<p><b>Minimum spacing and edge distance</b></p>	
	<p>min. edge distance <math>c_1, c_2 \geq 100 \text{ mm}</math></p> <p>min. spacing <math>s_1, s_2 \geq 200 \text{ mm}</math></p> <p>min. spacing between anchor groups <math>a_1, a_2 \geq 200 \text{ mm}</math></p>

electronic copy of the eta by dibt: eta-15/0785

**MULTI-MONTI-plus**

**Intended Use**  
Installation parameters for use in prestressed hollow core slabs

**Annex B 3**

## Installation instructions

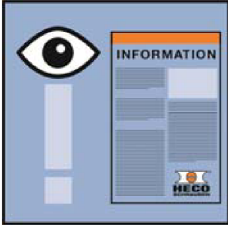

Check information in the approval!

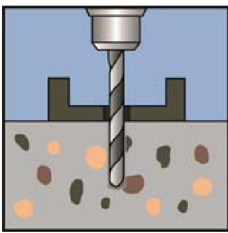

Create borehole using a Rotary Hammer.

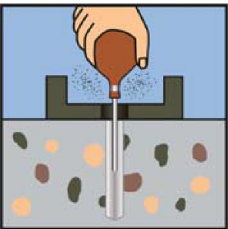

Clean borehole, e.g. remove dust with compressed air.

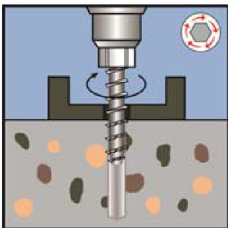

Install the screw anchor with an impact wrench or by hand.

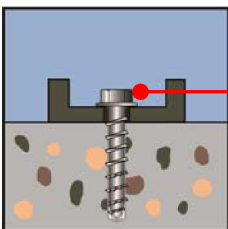

Check: The anchor head is fully supported on the fixture and not damaged, respectively the required embedment depth is reached.

**MULTI-MONTI-plus**

Intended Use  
Installation instruction

**Annex B 4**

## Installation instructions for use in prestressed hollow core slabs

Check the information given in the approval!

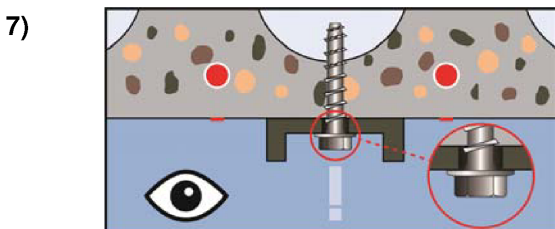
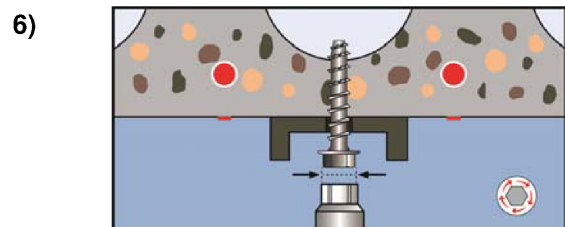
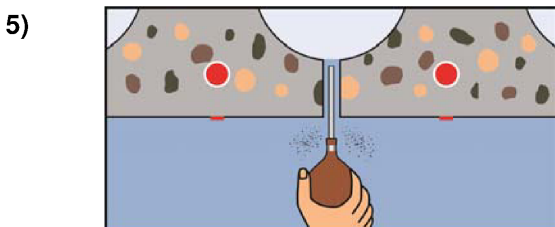
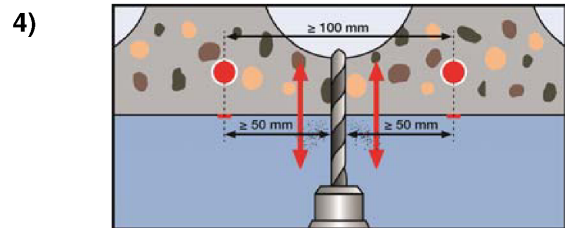
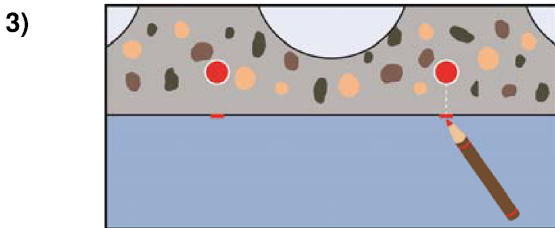
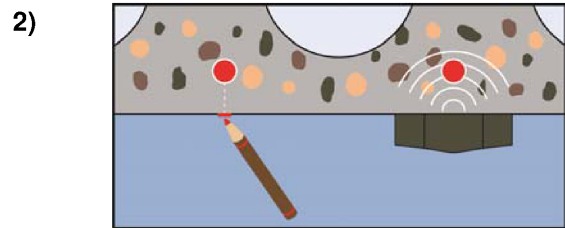
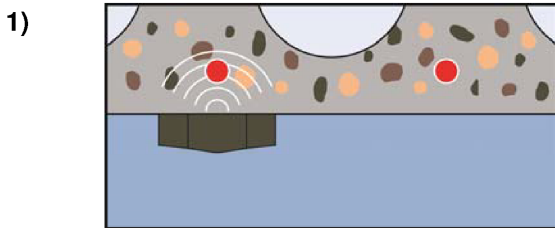
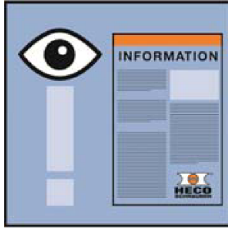

electronic copy of the eta by dibt: eta-15/0785

### MULTI-MONTI-plus

**Intended Use**  
Installation instruction for use in prestressed hollow core slabs

**Annex B 5**

**Table C1: Characteristic values for static and quasi-static loading of MMS-plus**

Size MMS-plus			6			7,5			10
			h <sub>nom</sub>			h <sub>nom</sub>			h <sub>nom</sub>
Embedment depth in concrete	[mm]		25	35	45	25	35	55	50
<b>Steel failure for tension- and shear load</b>									
Characteristic resistance	N <sub>Rk,s</sub>	[kN]	10,8			17,6			32,1
Partial safety factor	γ <sub>Ms</sub>	-	1,50						
Characteristic resistance	V <sub>Rk,s</sub>	[kN]	4,1			8,8			13,7
Partial safety factor	γ <sub>Ms</sub>	-	1,25						
	k <sub>7</sub>	-	0,8						
Characteristic resistance	M <sup>0</sup> <sub>Rk,s</sub>	[Nm]	6,7			14,1			34,5
<b>Pull-out</b>									
Characteristic resistance in uncracked concrete C20/25	N <sub>Rk,p</sub>	[kN]	2,0	5,5	8,0	2,0	5,0	5,0	5,0
Characteristic resistance in cracked concrete C20/25	N <sub>Rk,p</sub>	[kN]	1,0	1,0	1,5	1,0	2,5	5,0	5,0
Increasing factor for concrete	C25/30	ψ <sub>c</sub>	-	1,12					
	C30/37			1,22					
	C40/50			1,41					
	C50/60			1,58					
<b>Concrete cone failure and splitting failure</b>									
Effective anchorage depth	h <sub>ef</sub>	[mm]	16	26	35	16	26	43	36
Factor for	cracked	k <sub>cr,N</sub>	7,7						
	uncracked	k <sub>urc,N</sub>	11,0						
Concrete cone	edge distance	c <sub>cr,N</sub>	1,5 h <sub>ef</sub>						
	spacing	s <sub>cr,N</sub>	3 h <sub>ef</sub>						
Splitting	edge distance	c <sub>cr,sp</sub>	2,0 h <sub>ef</sub>						
	spacing	s <sub>cr,sp</sub>	4,0 h <sub>ef</sub>						
Installation factor		-	1,4	1,0		1,4	1,0		
<b>Concrete pryout failure</b>									
k-Faktor	k <sub>8</sub>	-	1,0						
<b>Concrete edge failure</b>									
Effective length of the anchor	l <sub>f</sub> = h <sub>ef</sub>	[mm]	16	26	35	16	26	43	36
Effective diameter of the anchor	d <sub>nom</sub>	[mm]	5			6			8

**MULTI-MONTI-plus**

**Performance**  
Characteristic values for static and quasi static tension loads

**Annex C 1**



**Table C2: Characteristic values for static and quasi-static loading of MMS-plus in prestressed hollow core slabs C30/37 to C50/60**

Size MMS-plus			6			7,5			10	
			$d_b$			$d_b$			$d_b$	
Thickness of slab web	[mm]		30	40	50	30	40	50	40	50
<b>All load directions</b>										
Characteristic resistance in concrete $\geq$ C30/37	$F_{RK}^0$	[kN]	1,0	5,5	6,5	1,2	4,5	8,0	6,5	11,0
Characteristic resistance in concrete $\geq$ C45/55	$F_{RK}^0$	[kN]	4,5	6,0	6,0	4,0	8,0	8,0	11,5	12,0
Partial safety factor	$\gamma_M$	-	1,5							
Installation factor	$\gamma_{inst}$	-	1,0							
Edge distance	$c_{cr} = c_{min}$	[mm]	100			100	120		140	
Spacing	$s_{cr} = s_{min}$	[mm]	200							

**Table C3: Characteristic values under fire exposure**

Size MMS-plus			6		7,5		10	
			$h_{nom}$		$h_{nom}$		$h_{nom}$	
Embedment depth in concrete	[mm]		35	45	35	55	50	
<b>Characteristic resistance for tension and shear</b>								
Characteristic resistance	R30	$F_{RK,fi}$	[kN]	0,3	0,4	0,5	1,1	1,3
	R60	$F_{RK,fi}$	[kN]	0,3	0,4	0,5	0,8	1,3
	R90	$F_{RK,fi}$	[kN]	0,3	0,4	0,5	0,5	1,0
	R120	$F_{RK,fi}$	[kN]	0,2	0,3	0,4	0,4	0,8
	R30	$M_{RK,s,fi}^0$	[Nm]	0,5		1,1		2,7
	R60	$M_{RK,s,fi}^0$	[Nm]	0,3		0,6		1,5
	R90	$M_{RK,s,fi}^0$	[Nm]	0,2		0,4		1,1
	R120	$M_{RK,s,fi}^0$	[Nm]	0,2		0,3		0,9
R30 to R120	$c_{cr,fi}$	[mm]	2 $h_{ef}$					
R30 to R120	$s_{cr,fi}$	[mm]	2 $c_{cr,fi}$					

**MULTI-MONTI-plus**

**Performance**  
Characteristic values under fire exposure

**Annex C 2**







**HECO-Schrauben GmbH & Co.KG**

Dr.-Kurt-Stein-Straße 28 · D-78713 Schramberg

Tel.: +49 (0) 74 22 / 9 89-0 · Fax: +49 (0) 74 22 / 9 89-200

Mail: [info@heco-schrauben.de](mailto:info@heco-schrauben.de) · [www.heco-schrauben.de](http://www.heco-schrauben.de)